



## Part 1 - GENERAL

### Scope

The framing shall be Metro "F" Series single glazed flushline system as manufactured by Metro Glass. Furnish all materials, labour and services for the complete fabrication, assembly and installation of aluminum framing as required based on the contract or the purchase agreement.

**Work Not Included:** Structural support for framing, wood liner, interior or exterior closures or trim.  
(See Specifiers list of other exclusions.)

**Related Work Specified Elsewhere:** See Specifier List

### Design & Performance

Framing to fully comply with applicable standard specifications as typically referenced to the following requirement criteria: Air and water tightness, wind and other load resistance.

### Maintenance and Warranty

Provide maintenance and cleaning data in accordance with instructions under General Conditions. Metro Glass supplies a one year warranty which shall begin from the day the product is shipped or from substantial completion of the installation of materials and on the workmanship provided under this section.

## Part 2 - PRODUCTS

### Materials

All materials to meet design and material specifications as applicable. Extruded aluminum shall be 6063 T5 alloy and temper. Any defects impairing strength, durability or appearance are not acceptable. Fasteners shall be of sufficient size and strength and made of corrosion-resistant and compatible materials. Glazing gaskets shall be extruded black santoprene designed and sized to perform their intended function.

### Fabrication

Frame assembly to provide accurately fit tight hairline joints only. Extruded profiles to be of sizes and profiles indicated in the contract or the purchase agreement. Corner joints shall be secured with concealed shear blocks with fastening by means of anticorrosive steel screws.

### Finish

Exposed surfaces shall be finished as selected by Specifier.

Standard Clear Anodizing: AA-M12C22A31

Standard Bronze Anodizing: AA-M12C22A34

Standard Black Anodizing: AA-M12C22A44

Duracron Acrylic Enamel: AAMA 603.8

Duramar Fluoropolymer paint: AAMA 605.2

Powdercoated finishes available.

Various Bronze Anodizing colours and paint qualities are available upon request.

### Installation

Framing to be installed plumb, level and square and glazed by an experienced crew in prepared openings in accordance to the manufacturers instructions and approved shop drawings.

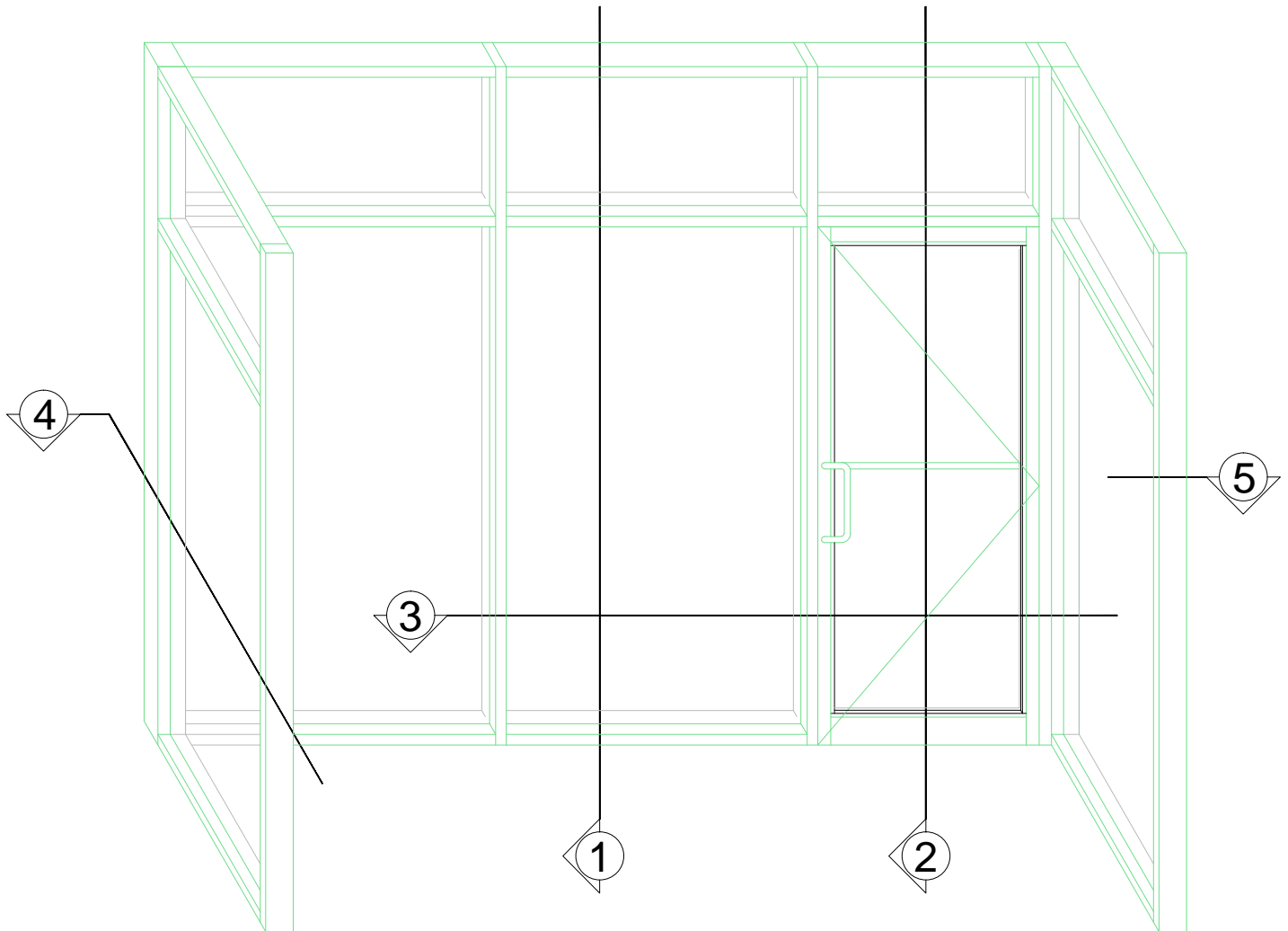

### F SERIES: FLUSHLINE

A POPULAR CHOICE FOR INTERIOR APPLICATIONS.

A SINGLE GLAZED SYSTEM USED FOR VESTIBULES, OFFICE PARTITIONS  
AND OTHER GLAZING NEEDS.

CAN BE FABRICATED TO SUIT MOST OPENING REQUIREMENTS.



**METRO GLASS**  
PRODUCTS LTD.

# F SERIES STOREFRONT SECTION DETAILS

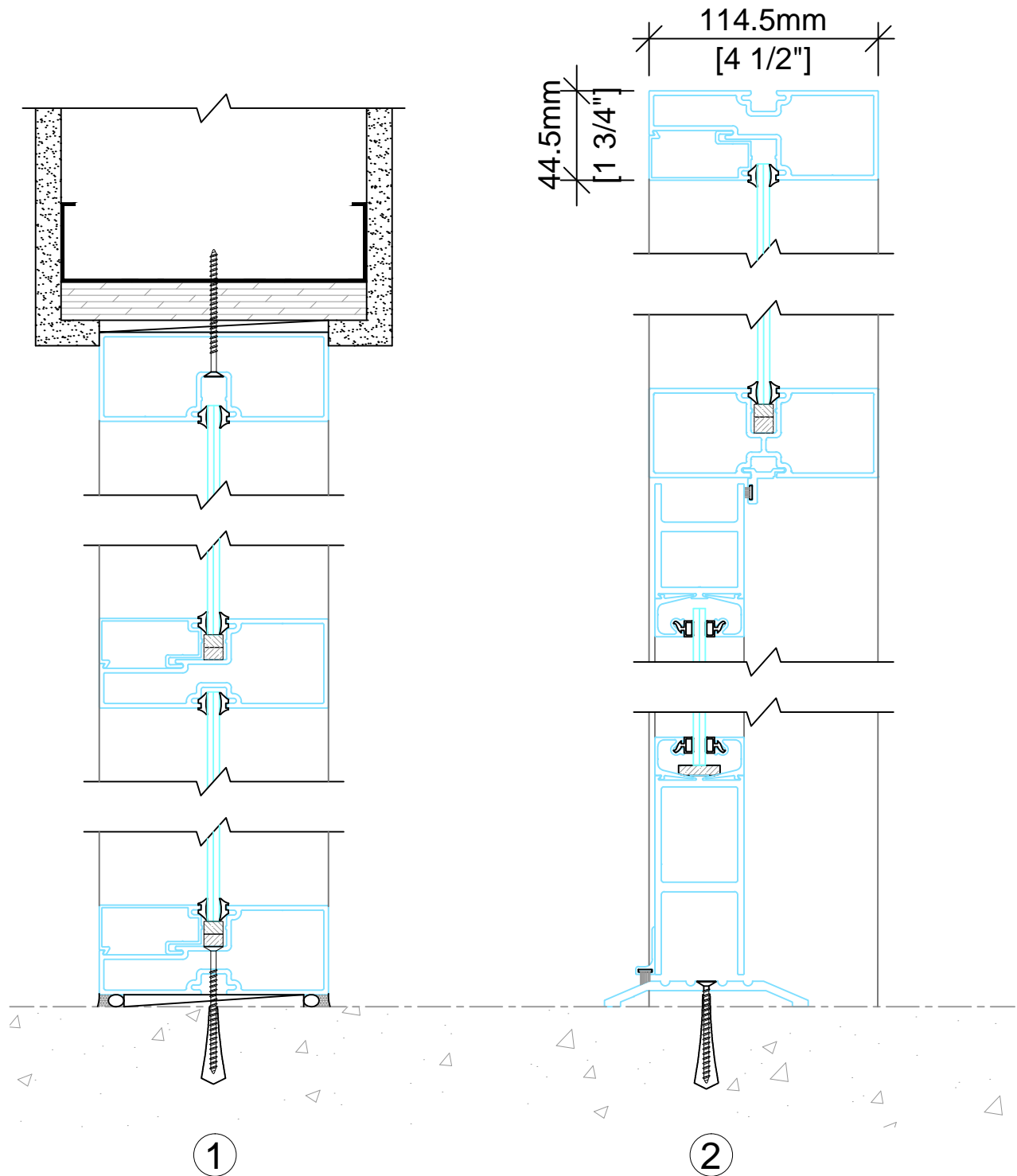

50 Years of Manufacturing Innovative Aluminum Doors, Frames, Curtain Walls, Windows and Vents

Bay 108 - 1626 115 Ave. N.E.

Calgary, Alberta T3K 2E4

Phone: 403-250-9290

Fax: 403-291-0599

Toll Free: Phone: 1-877-919-0906

Fax: 1-877-919-0905

[www.metroglass.ca](http://www.metroglass.ca)

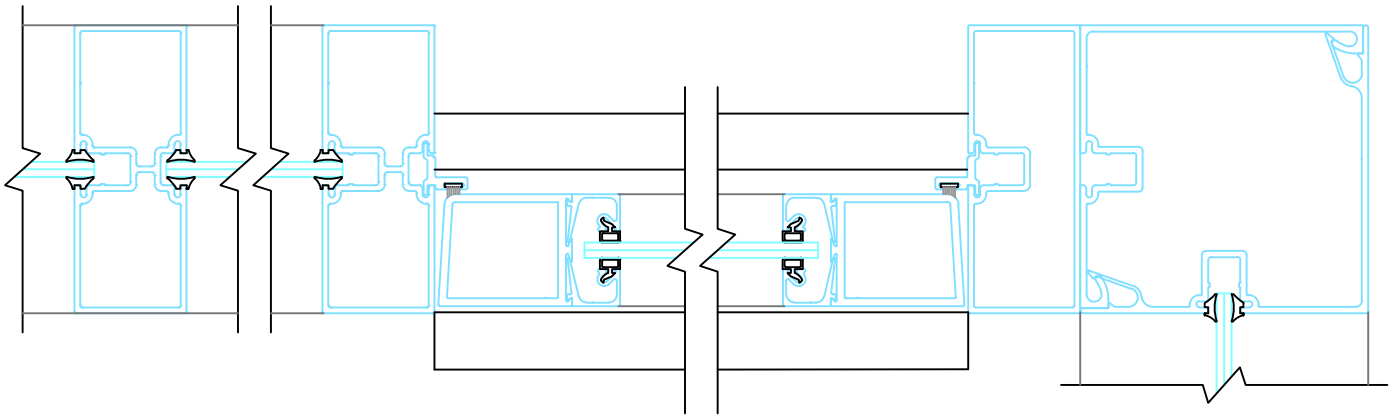

3

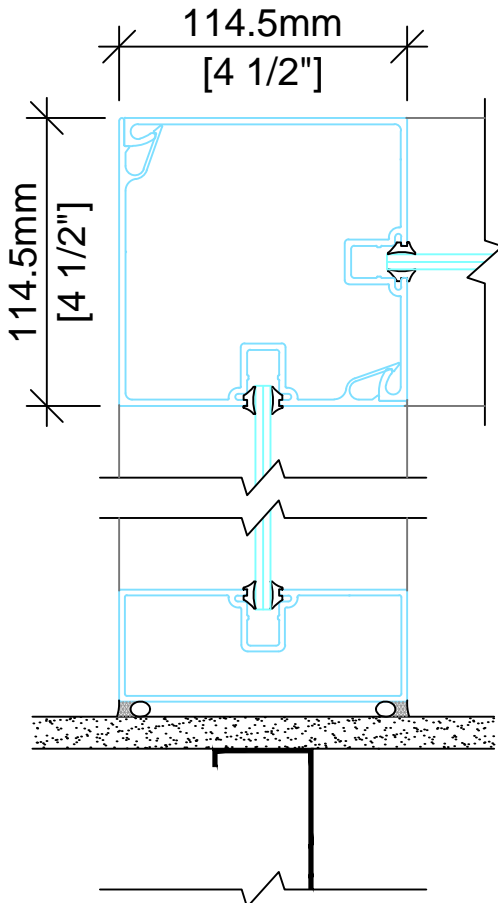

4

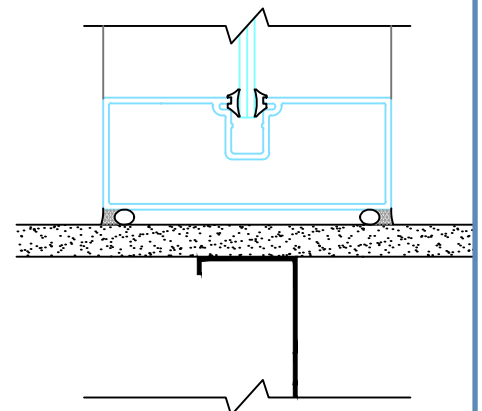









5

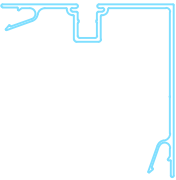
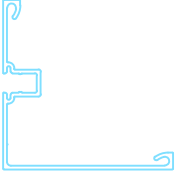

**METRO GLASS**  
PRODUCTS LTD.

## F SERIES STOREFRONT PARTS

| PART  | NO.  | DESCRIPTION  | STOCK LENGTH IN METRES | CLEAR ANODIZED | BRONZE ANODIZED | BLACK ANODIZED |
|---|------|--|------------------------|----------------|-----------------|----------------|
|    | F-1  | 1 3/4" X 4 1/2" MULLION<br>(44.5mm X 114.3mm)                            | 7.3                    | ✓              | ✓               | ✓              |
|    | F-2  | 1 3/4" X 4 1/2" HORIZONTAL<br>(44.5mm X 114.3mm)                         | 7.3                    | ✓              | ✓               | ✓              |
|    | F-4  | HORIZONTAL STOP  | 7.3                    | ✓              | ✓               | ✓              |
|    | F-5  | 1 3/4" X 4 1/2" MULLION<br>(44.5mm X 114.3mm)                            | 7.3                    | ✓              | ✓               | ✓              |
|   | F-6  | FEMALE CORNER MULLION  | 5.5                    | ✓              | ✓               | ✓              |
|  | F-7  | MALE CORNER MULLION  | 5.5                    | ✓              | ✓               | ✓              |
|  | F-8  | F SERIES DOOR STOP   | 6.71                   | ✓              | ✓               | ✓              |
|  | F-10 | SHEAR BLOCK  | 7.3                    | MILL FINISH    |                 |                |
|  | F-11 | SHEAR BLOCK  | 7.3                    | MILL FINISH    |                 |                |
|  |      | GLAZING SPLINE WEDGE GASKET<br>AVAILABLE THICKNESS<br>.090 - .120 - .170 |                        |                |                 |                |
|   |      |  |                        |                |                 |                |

50 Years of Manufacturing Innovative Aluminum Doors, Frames, Curtain Walls, Windows and Vents

Bay 108 - 1626 115 Ave. N.E.

Calgary, Alberta T3K 2E4

Phone: 403-250-9290

Fax: 403-291-0599

Toll Free: Phone: 1-877-919-0906

Fax: 1-877-919-0905

[www.metroglass.ca](http://www.metroglass.ca)