

Part 1 - GENERAL

Scope

The framing shall be Metro "A" Series tube and stop system as manufactured by Metro Glass. Furnish all materials, labour and services for the complete fabrication, assembly and installation of aluminum framing as required based on the contract or the purchase agreement.

Work Not Included: Structural support of framing, interior building trims, and as specified by drawings and customer requirements per contract or purchase agreement.

Quality Assurance

Drawings and specification for work in this section are based upon Metro "A" Series framing system.

Design & Performance

Framing to fully comply with applicable standard specifications as typically referenced to the following requirement criteria: Air and water tightness, wind and other load resistance.

Maintenance and Warranty

Upon request, Metro will provide instructions for proper cleaning and maintenance. Metro Glass Metal Products come with a two year warranty which shall begin from the day the product is shipped or from substantial completion of the installation. The warranty covers materials and workmanship as specified by drawings and customer requirements per contract or purchase agreement.

Part 2 - PRODUCTS

Materials

All materials to meet design and material specifications as applicable. Extruded aluminum shall be 6063 T5 alloy and temper. Any defects impairing strength, durability or appearance are not acceptable.

Fasteners shall be of sufficient size and strength and made of corrosion-resistant and compatible materials.

Glazing tape shall be Tremco 440 Tape 100% solid Polyisobutylene cross-linked butyl, preformed sealant designed and sized to perform the intended function.

Fabrication

Frame assembly to provide accurately fit tight hairline joints only. Extruded profiles to be of sizes and profiles indicated in the contract or the purchase agreement. Corner joints shall be secured with concealed shear blocks with fastening by means of anticorrosive steel screws, and as specified by drawings and customer requirements per contract or purchase agreement.

Finish - Anodized 6063 Material Code Identification

Exposed surfaces shall be finished as specified by customer:

Satin Clear 14 AA-M12C22A41

Satin Medium Bronze 30 AA-M12C22A44

Satin Black 29 AA-M12C22A44

Powdercoated and various other finishes (including shades of Bronze) available upon request.

Installation

Framing to be installed plumb, level and square and glazed by an experienced crew in prepared openings in accordance to the manufacturers instructions and approved shop drawings, and as specified by drawings and customer requirements per contract or purchase agreement.

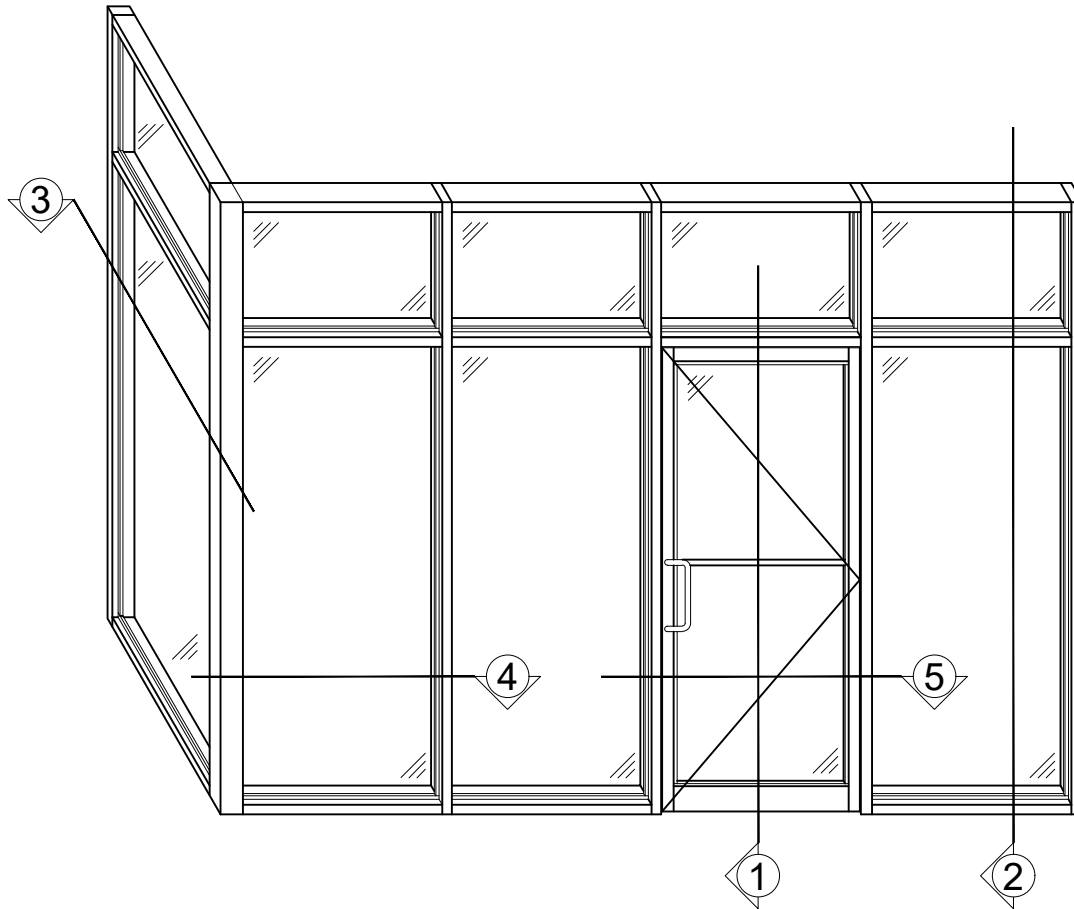

A SERIES: FIN TUBE & STOP

AN ECONOMICAL FRAMING SOLUTION FOR EXTERIOR & INTERIOR APPLICATIONS.

CAN BE USED WITH SINGLE GLAZING OR SEALED UNIT DOUBLE GLAZING.

CAN BE FABRICATED TO SUIT MOST OPENING REQUIREMENTS.

More than 50 Years of Manufacturing Innovative Aluminum Doors, Frames, Curtain Walls, Windows and Vents

Bay 108 - 1626 115 Ave. N.E. Calgary, Alberta T3K 2E4

Phone: 403-250-9290 Fax: 403-291-0599

www.metroglass.ca

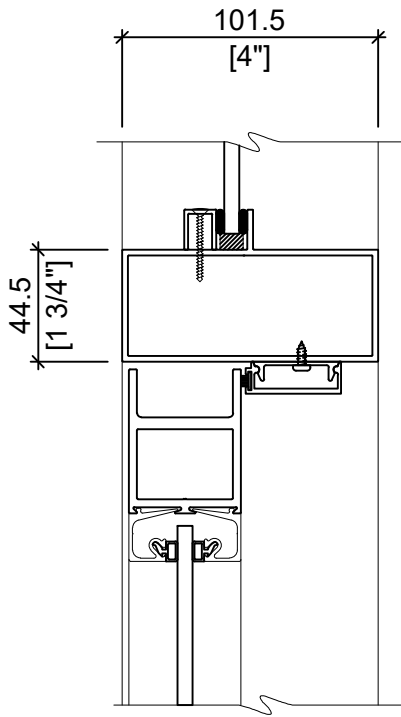

ALTERNATE 2 PART
DOOR STOP DETAIL

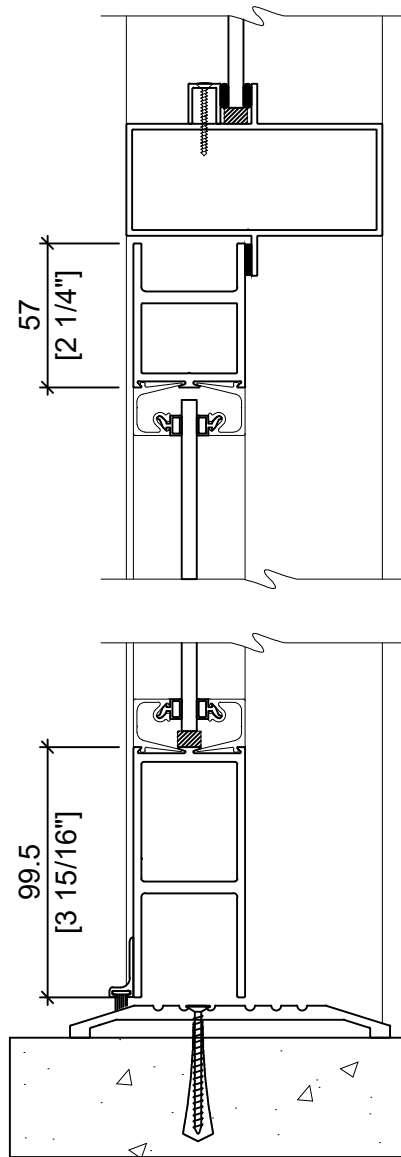

①

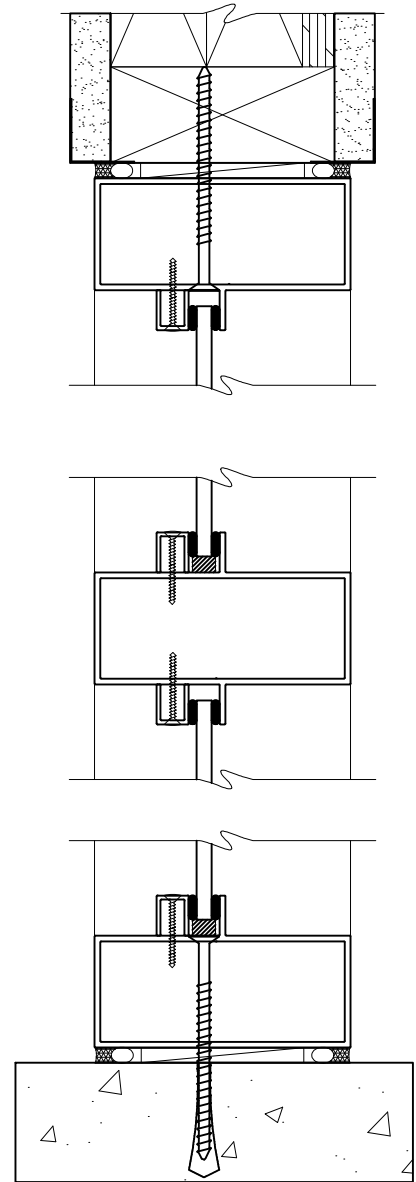

②

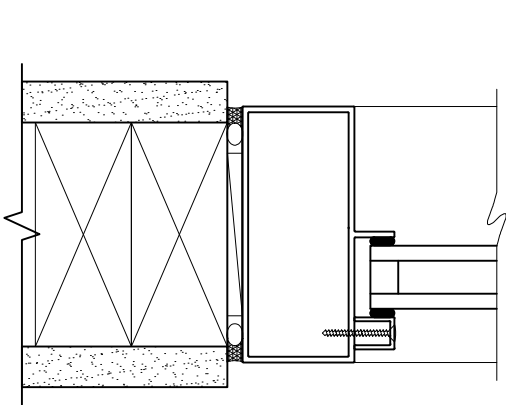

3

A SERIES: FIN TUBE &
STOP WITH SEALED UNIT

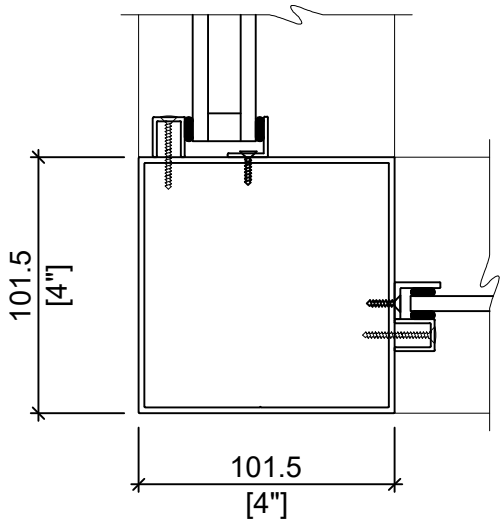
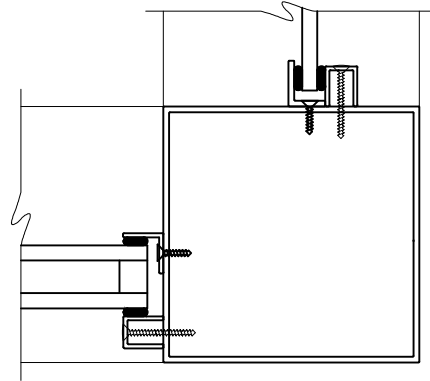

4

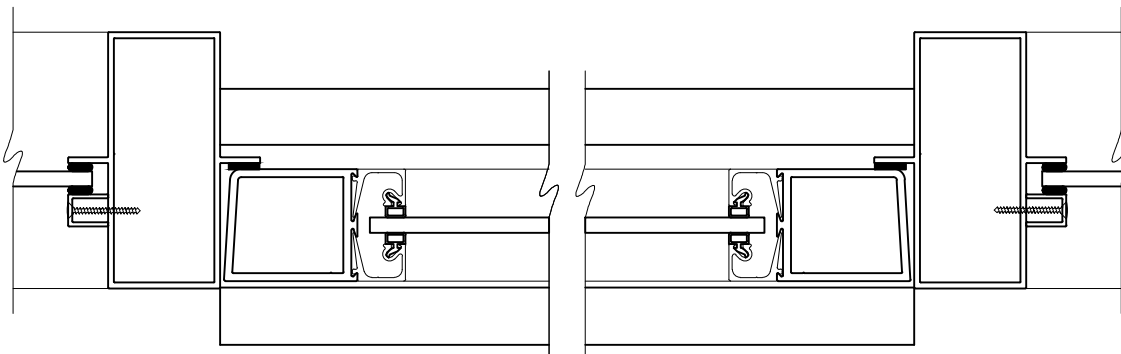
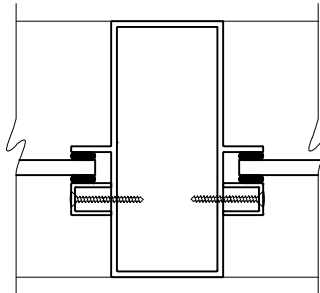

5









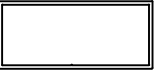

More than 50 Years of Manufacturing Innovative Aluminum Doors, Frames, Curtain Walls, Windows and Vents

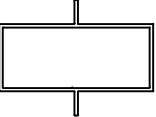
Bay 108 - 1626 115 Ave. N.E. Calgary, Alberta T3K 2E4

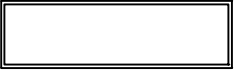
Phone: 403-250-9290 Fax: 403-291-0599

www.metroglass.ca

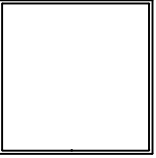
A SERIES STOREFRONT PARTS

CROSS SECTION	PART #	DESCRIPTION	STOCK LENGTH	CLEAR ANODIZED	BRONZE ANODIZED	BLACK ANODIZED
	A1	1 3/4" X 4" TUBE (44.5mm X 101.6mm)	7.315 m	✓	✓	✓
	A4	1 3/4" X 4" SINGLE FIN TUBE (44.5mm X 101.6mm)	4.6 m	✓	✓	✓
	A5	1 3/4" X 4" DOUBLE FIN TUBE (44.5mm X 101.6mm)	4.6 m	✓	✓	✓
	A10	1 3/4" X 4 1/2" TUBE (44.5mm X 114.3mm)	7.315 m	✓	✓	✓
	A11	1 3/4" X 6" TUBE (44.5mm X 152.4mm)	7.315 m	✓	✓	✓
	A12	1 3/4" X 1 3/4" TUBE (44.5mm X 44.5mm)	4.6 m	✓	✓	✓
	A17	1" X 4" TUBE (25.4mm X 101.6mm)	4.6 m	✓	✓	✓
	A6	1/2" X 5/8" GLASS STOP (12.7mm X 15.9mm)	4.6 m	✓	✓	✓
		5/8" X 5/8" ANGLE (15.9mm X 15.9mm X 1.6mm)	3.65 m	✓	✓	✓
	A20	4" X 4" TUBE (101.6mm X 101.6mm)	7.315 m	✓	✓	✓
	A19	1 3/4 X 1 9/16 X 1 3/4 3/16 WALL	4.6 m	MILL FINISH ONLY		
		440 BUTYL TAPE (1/8)	7.62 m ROLLS	COMES IN BLACK AND GREY		





More than 50 Years of Manufacturing Innovative Aluminum Doors, Frames, Curtain Walls, Windows and Vents

Bay 108 - 1626 115 Ave. N.E. Calgary, Alberta T3K 2E4

Phone: 403-250-9290 Fax: 403-291-0599

www.metroglass.ca

A SERIES STOREFRONT PARTS

CROSS SECTION	PART #	DESCRIPTION	STOCK LENGTH	CLEAR ANODIZED	BRONZE ANODIZED	BLACK ANODIZED
	D24	DOOR STOP BASE	4.6 m	✓		
	D26	1/2" DOOR STOP COVER	4.6 m	✓	✓	✓
	D27	5/8" DOOR STOP COVER	4.6 m	✓	✓	✓
	27078	DOOR STOP COVER BULB SEAL	150 m ROLLS	SILICONE		
	METRO	STICK ON BULB RUBBER SEAL	5.48 m ROLL	COMES IN BLACK		

More than 50 Years of Manufacturing Innovative Aluminum Doors, Frames, Curtain Walls, Windows and Vents

Bay 108 - 1626 115 Ave. N.E. Calgary, Alberta T3K 2E4

Phone: 403-250-9290 Fax: 403-291-0599

www.metroglass.ca

A SERIES STOREFRONT WIND LOAD CHART

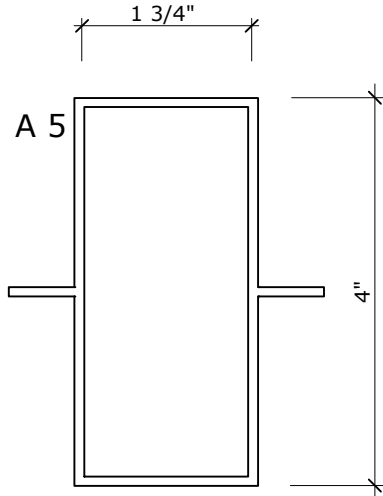

$I_{x-x} = 1.082 \text{ IN}^4$

$S_{x-x} = 0.541 \text{ IN}^3$

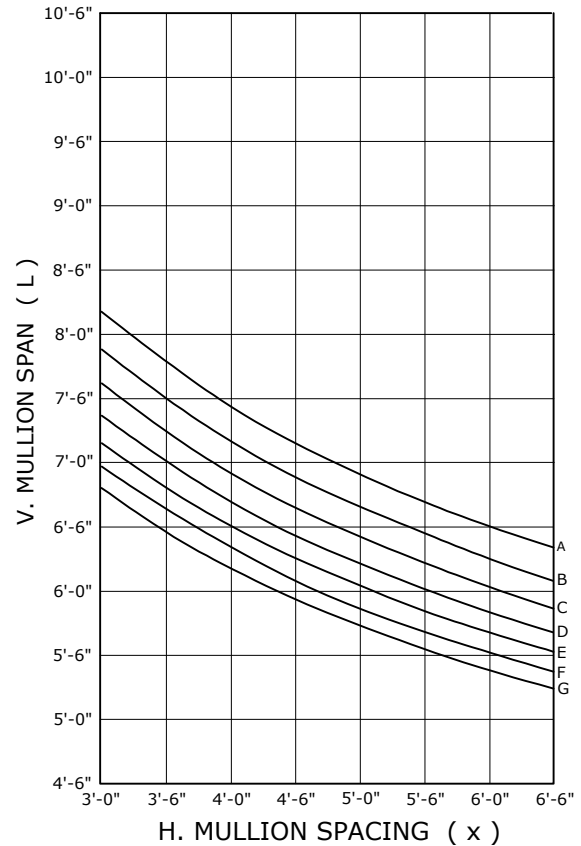

- A = 20.0 PSF
- B = 22.5 PSF
- C = 25.0 PSF
- D = 27.5 PSF
- E = 30.0 PSF
- F = 32.5 PSF
- G = 35.0 PSF

DEFLECTION = $L / 175$

More than 50 Years of Manufacturing Innovative Aluminum Doors, Frames, Curtain Walls, Windows and Vents

Bay 108 - 1626 115 Ave. N.E. Calgary, Alberta T3K 2E4

Phone: 403-250-9290 Fax: 403-291-0599

www.metroglass.ca